



11-0105 & 11-0107



TABLEAU D'AFFICHAGE NUMERIQUE INTERACTIF

INTERACTIVE DIGITAL NOTICE BOARD

DIGITALES UND INTERAKTIVES INFO-DISPLAY

INTERACTIEVE INFO DISPLAY

INTERAKTIV DIGITAL DISPLAYBOARD



intratone

INTRATONE
ZI de Maunit 370 rue de Maunit
85290 MORTAGNE SUR SEVRE
FRANCE

Pose en saillie/Surface-mounted/Aufputzmontage/Opbouwmontage/
Overflademontering

Ref : 11-0105

11-0107

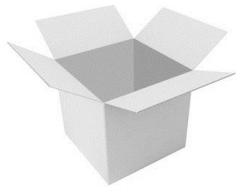

X1

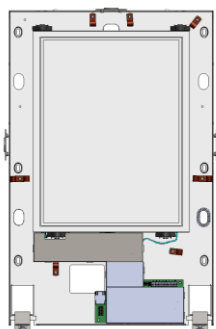

X1



X6

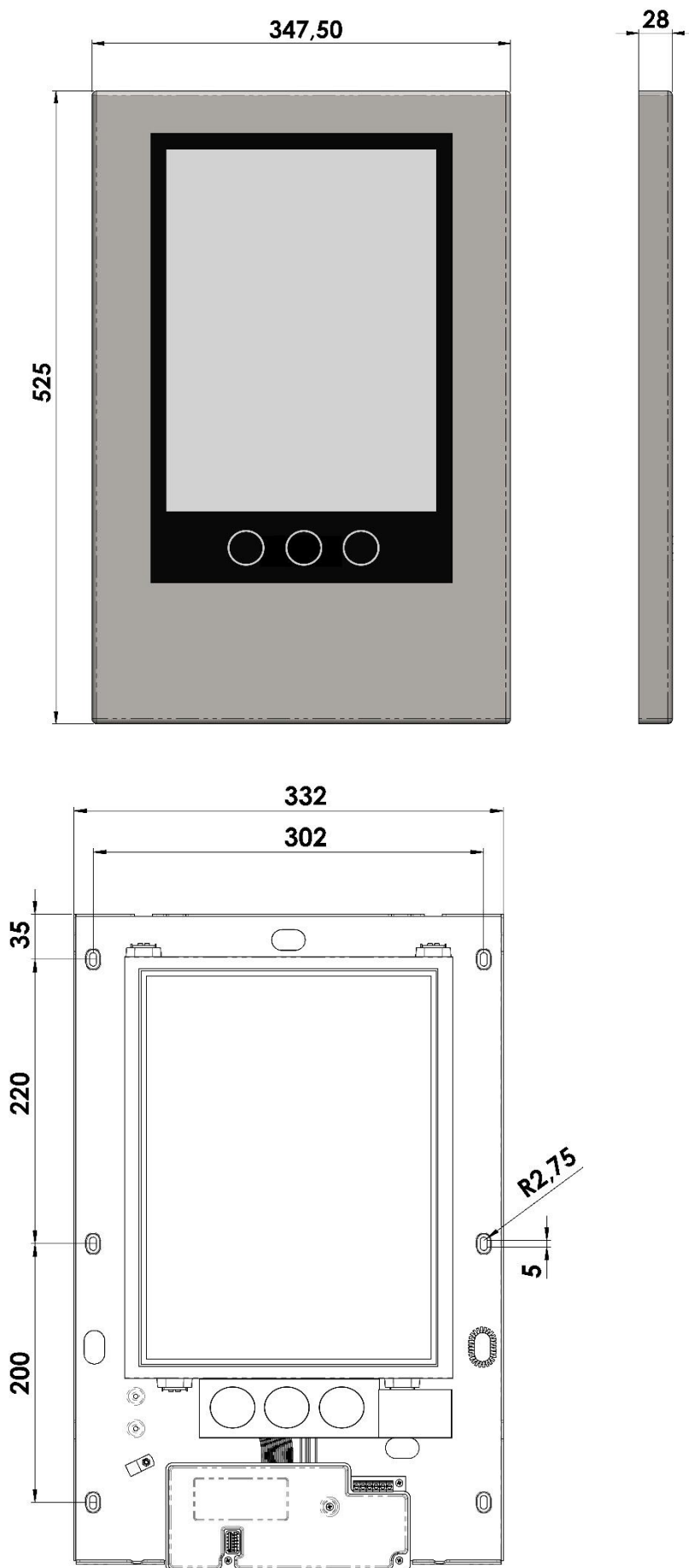

Montage / Fitting / Montage / Montage / Montering

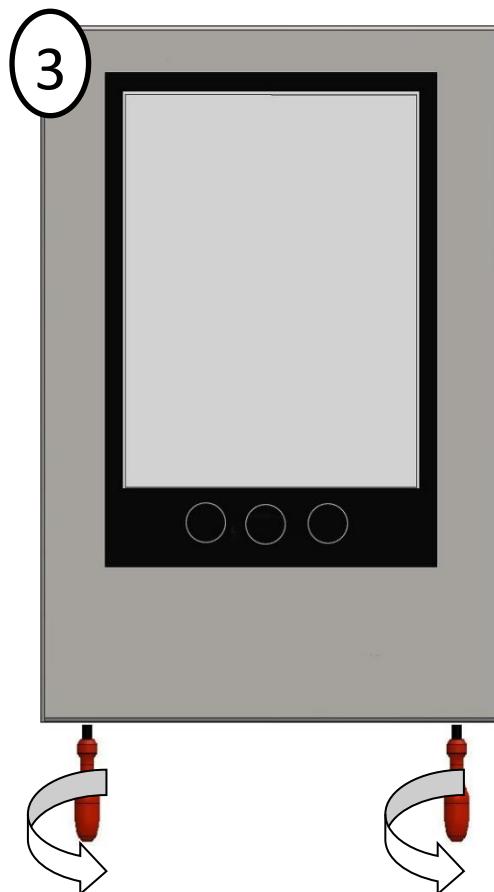
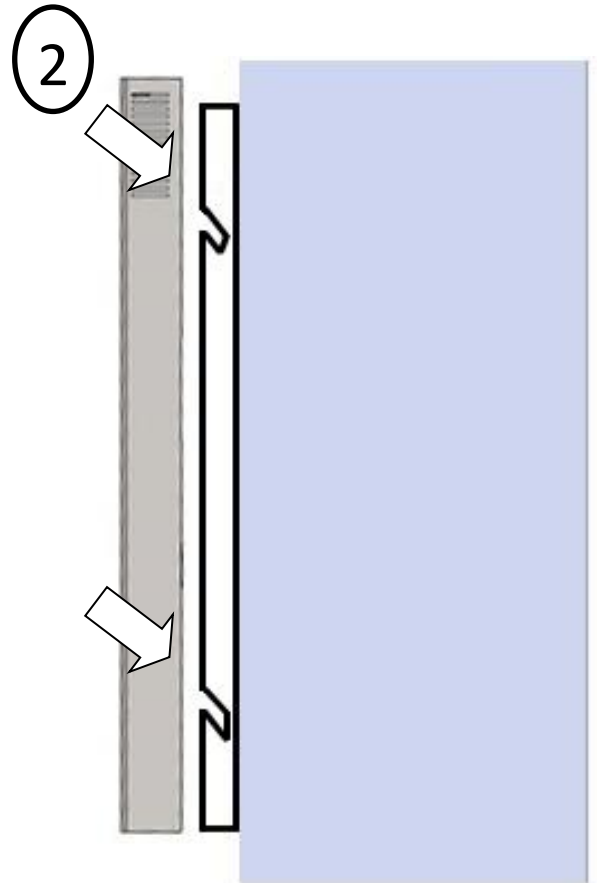
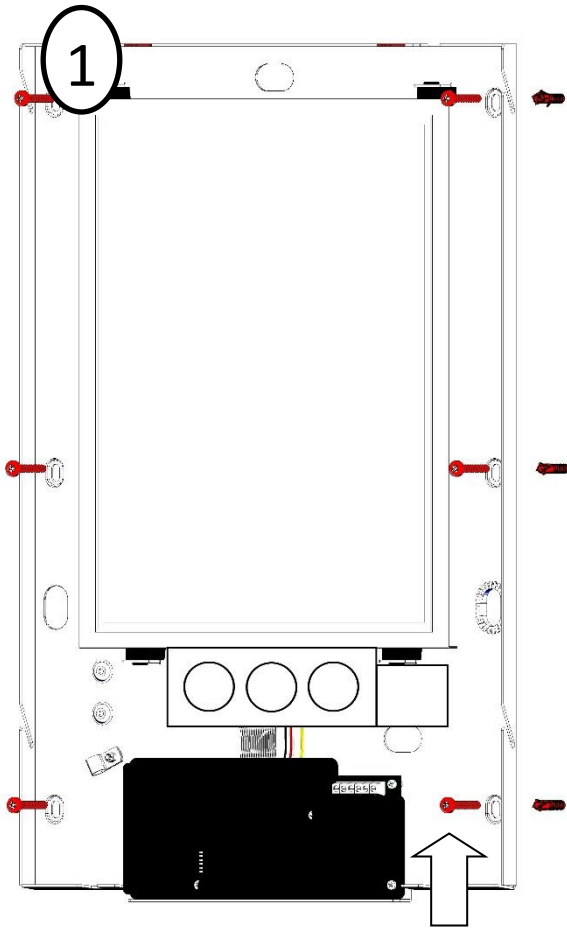

Câblage : alimentation commune

Cabling : common power supply

Verkabelung : gemeinsame Spannungsversorgung

Bekabeling : gemeenschappelijke voeding

Kabelføring: fælles strømforsyning

4G IP Module
17-0263

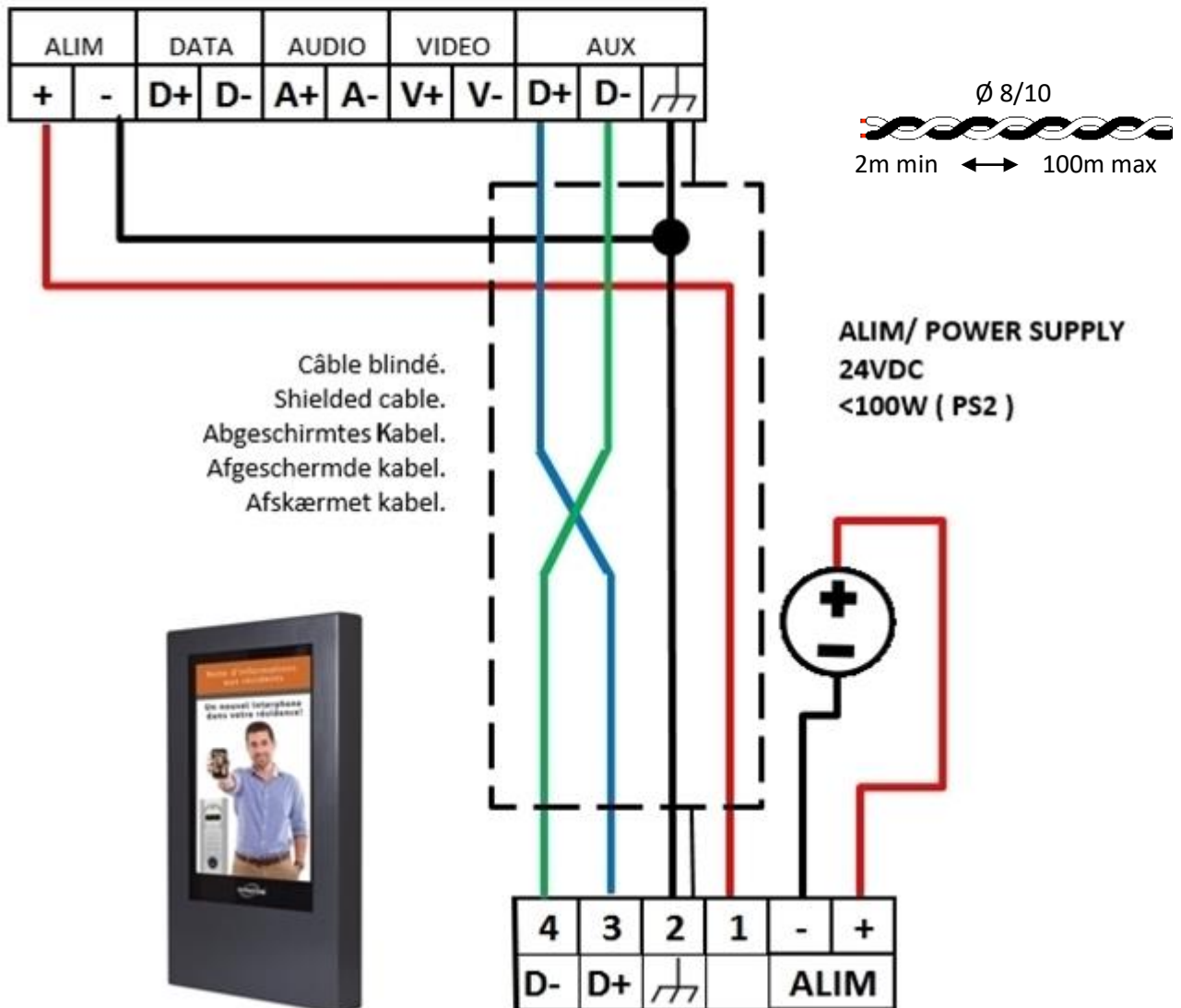

Câblage : alimentations séparées

Cabling : separate power supplies

Verkabelung : separate Netzteile

Bekabeling : afzonderlijke voedingen

Kabelføring: separate strømforsyninger



4G IP Module
17-0263 ✓

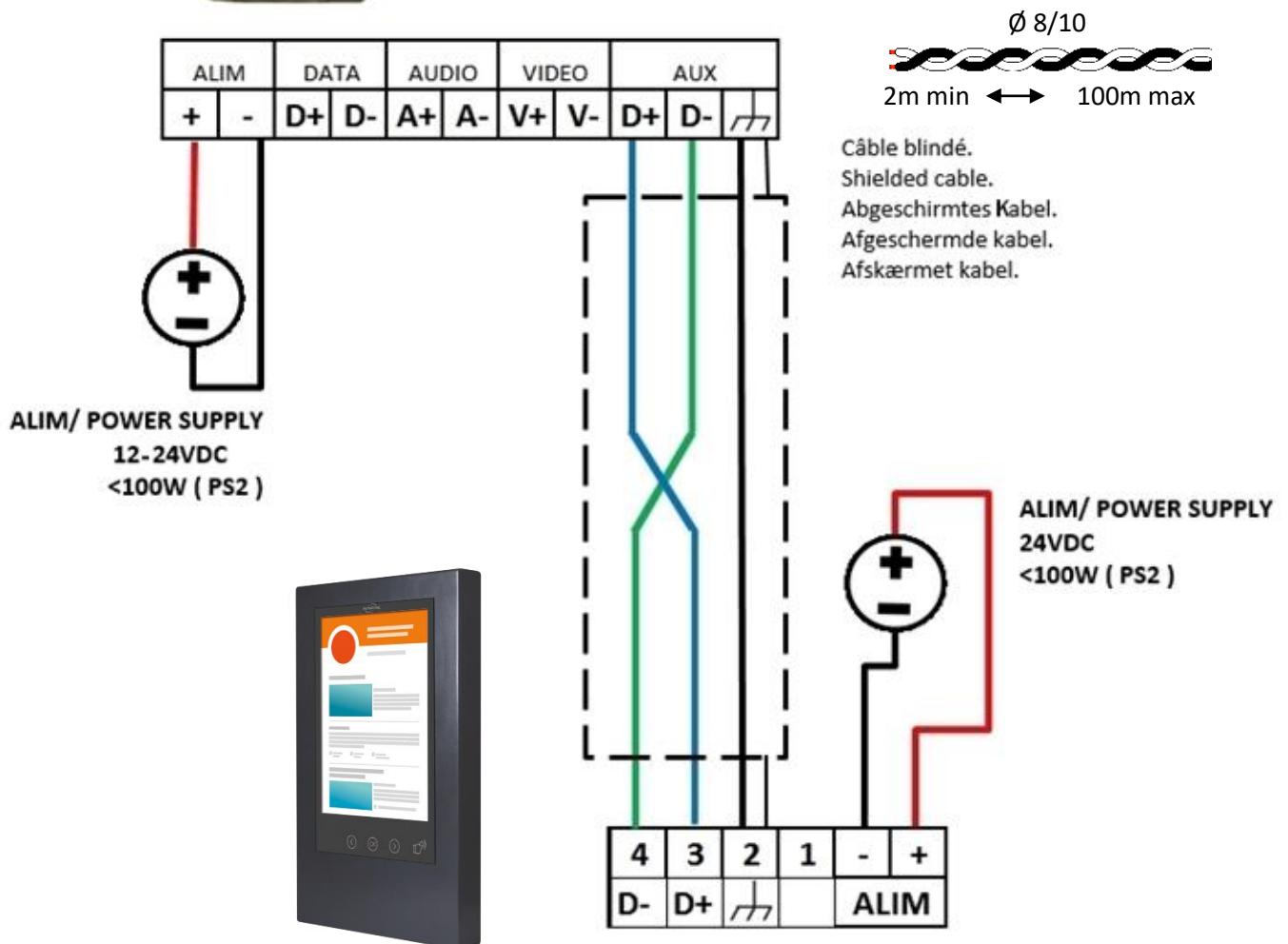

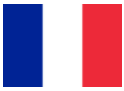

CONTRÔLER LE STATUT RESEAU DU TABLEAU

Appuyer sur les touches < et > en simultanément et relâcher.

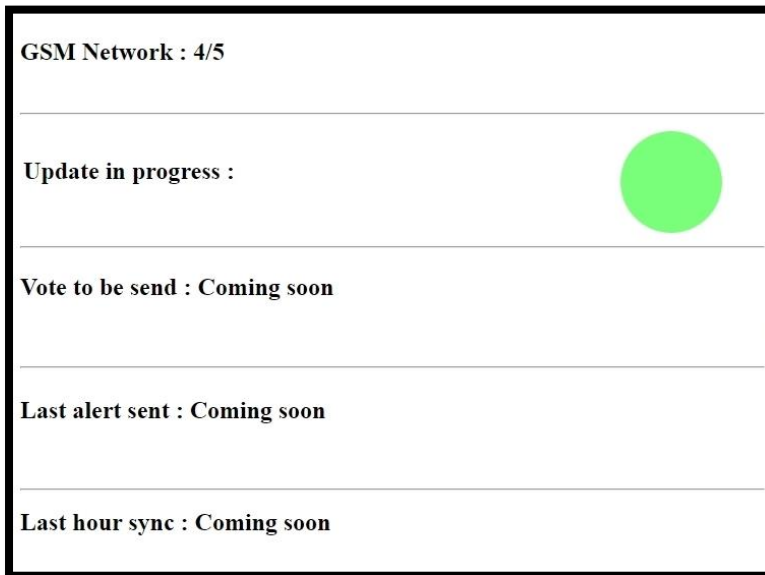

GSM Network X/5 : Niveau de réception du module 4G.

Update in progress : Le voyant est vert si une mise à jour est en cours.

Vote to be send : Les résultats du vote sont en attente de téléchargement.

Last alert sent : Dernière remontée d'alerte.

Last hour sync : Dernière synchronisation de l'heure du tableau.

TEST DES FONCTIONS PRINCIPALES



Basculer le Switch n°4 sur ON OU Appuyer pendant 5 secondes sur les touches tactiles gauche et droite.

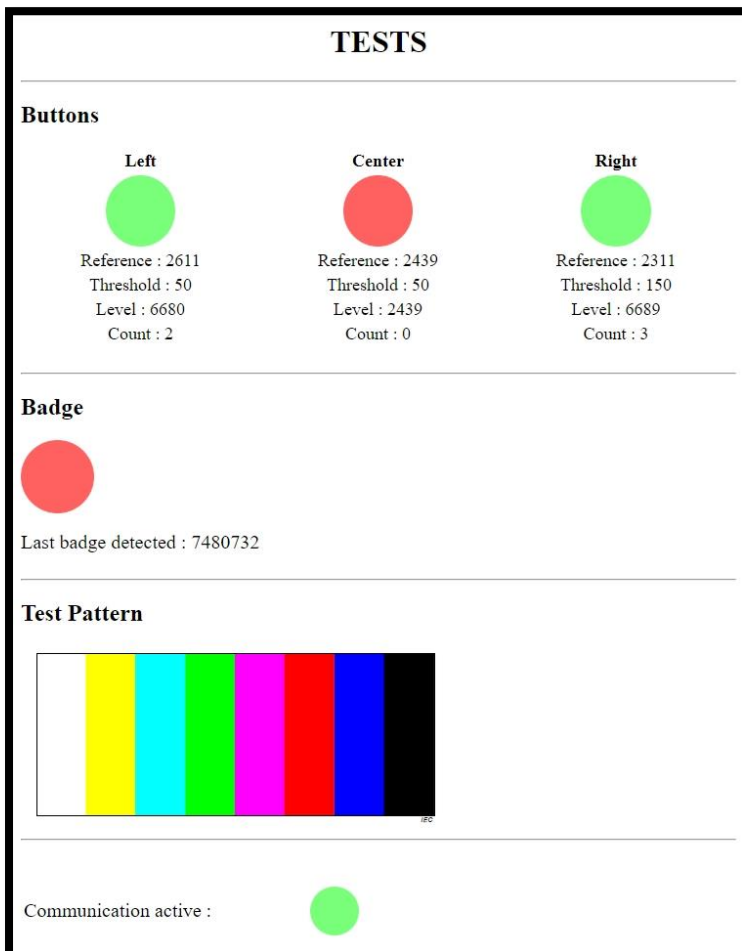

La page de test va s'afficher pendant 2 minutes.

L'appui sur une touche doit allumer le voyant correspondant en vert.

Le passage d'un badge permet de lire le n° du badge.

Mire de contrôle des couleurs.

Communication avec le port AUX du module 4G IP est valide.

Active = Vert

Inactive = Rouge

CALIBRATION DES TOUCHES TACTILE

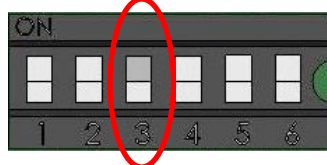

1	2	3
Basculer le Switch n°3 sur ON puis sur OFF	Vous avez 2 minutes pour fermer le tableau.	Suivre les étapes de paramétrage.

CONFIGURATION DU CONTRASTE

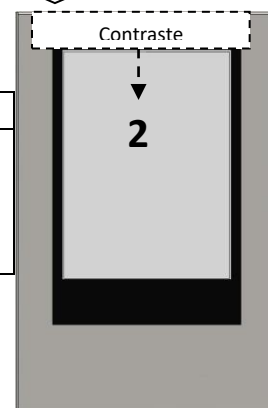
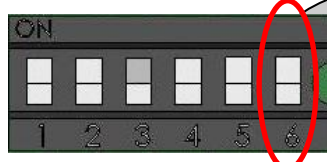

1	2	3	4
Basculer le Switch 6 sur ON et patienter	Sur l'écran, le chiffre affiché donne le niveau de contraste entre 1 et 4.	Quand le niveau est bon, basculer le Switch N°6 sur OFF.	Le tableau sauvegarde automatiquement le réglage.

RÉINITIALISATION DU TABLEAU

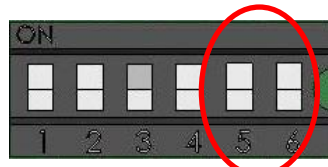

1	2	3	4	5
Basculer le Switch n°5 sur ON puis Switch n°6 sur ON	Le tableau affichera un message : ⇨ « Suivez les indications »	Eteindre et allumer le tableau.	Attendre que le tableau s'allume entièrement.	Basculer les switch n°5 et 6 sur OFF.

DEPANNAGE

<i>FR : Quelle est la panne ?</i>	<i>Comment résoudre la panne !</i>
Le tableau ne s'allume pas.	- Vérifier le câblage entre le bloc et le tableau : +/- - Vérifier l'alimentation (qui doit être une 24V).
Même après mise à jour depuis www.intratone.info l'écran n'affiche qu'un point blanc.	- Problème de câblage sur le BUS DATA
Mauvaise calibration des touches tactiles ou impossibilité de faire la calibration.	-Vérifier la mise à la terre de l'alimentation ou de la mécanique et relancer une calibration.

Spécifications techniques:

Tensions d'alimentation	24Vdc max. (ES1) < 100W (PS2)	
Caractéristiques radio	13.553 MHz - 13.567 MHz	< 60 dBµA/m @10m
Gamme de températures en stockage	-20 à/to +60°C	
Gamme de températures en fonctionnement	-20 à/to +60°C	
Environnement	IP52	



1

Aller dans le menu « Tableau »



2

Cliquer sur “ajouter un tableau” et choisir votre résidence



3

Vous pouvez maintenant ajouter des documents.
« Communication générale » pour publier sur tous vos tableaux.
« Actualité » pour publier sur un tableau en particulier.

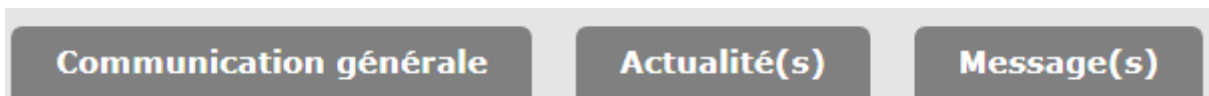

4

Cliquer sur mettre à jour pour envoyer votre document au tableau

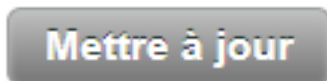

Garanties de fonctionnement :

Le tableau d’affichage FTA0014 est garanti dans une plage de température comprise entre -20°C et +60°C et pour une humidité relative maximum de 70%. Son indice IP est 52.

Doit être posé selon le sens Haut / Bas préconisé sur l’appareil.

Pour un fonctionnement optimal, il est préconisé de mettre l’alimentation ou la mécanique à la terre.

L’installation doit être réalisée par du personnel qualifié possédant les connaissances nécessaires à un montage sûr de l’équipement.



Recyclage du produit en fin de vie:

Le tableau d’affichage et ses accessoires ne doivent pas être mis au rebut avec les déchets municipaux non triés, mais doivent suivre la filière de collecte et de recyclage des produits DEEE (Déchets d’Equipements Electriques et Electroniques). <https://fr.calameo.com/read/005135075b80fd84ae250>



Déclaration de conformité simplifiée

Le soussigné, COGELEC, déclare que l’équipement radioélectrique du type contrôle d’accès pour l’habitat collectif est conforme à la directive 2014/53/UE (RED). Le texte complet de la déclaration UE de conformité est disponible à l’adresse internet suivante : <http://certificates.intratone.com/>



STATUS SCREEN

Press the <and> keys simultaneously.

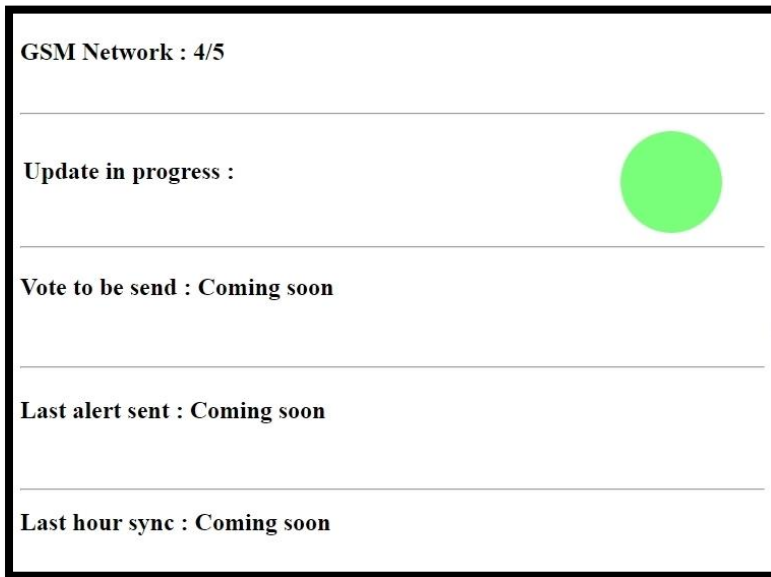

GSM Network X / 5: Reception level of the 4G module.

Update in progress: The indicator is green if an update is in progress.

Vote to be send: The results of the vote are pending download.

Last alert sent: Last alert report.

Last hour sync: Last time sync of the table.

MAIN FUNCTION TESTS

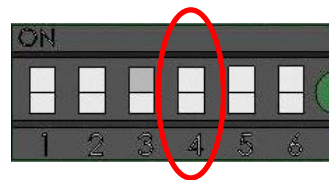

Toggle Switch # 4 to ON OR Press the left and right touch buttons for 5 seconds.

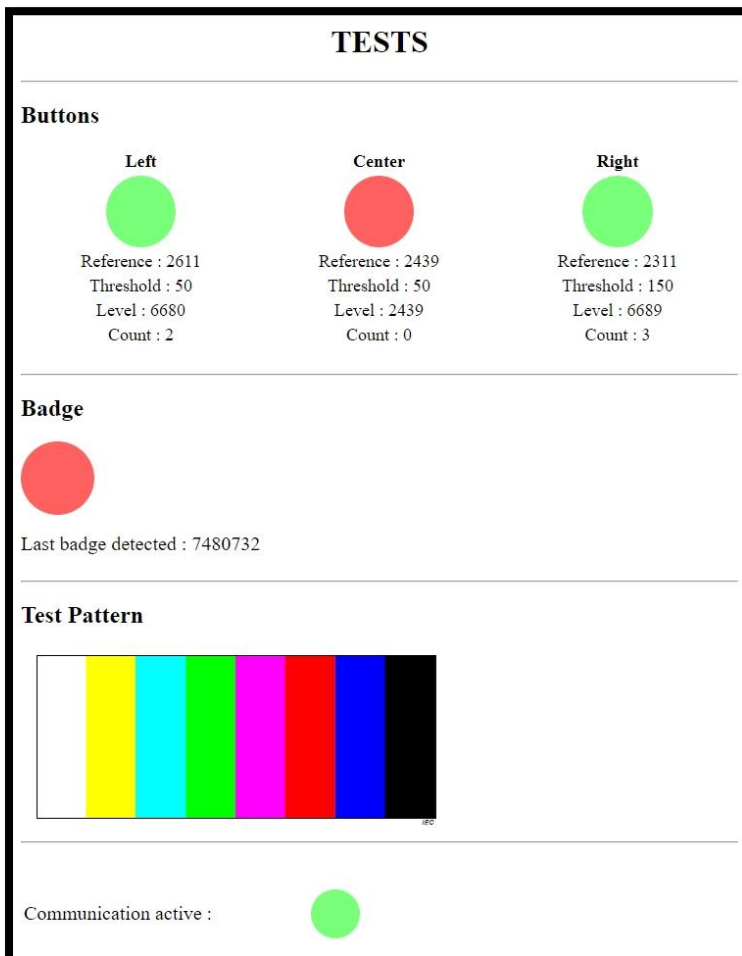

The test page will be displayed for 2 minutes.

Pressing a key should light the corresponding indicator.

Passing a badge allows you to read the badge number.

Colors control pattern.

Communication with the AUX port of the 4G IP module is valid.



TOUCH KEYS CALIBRATION

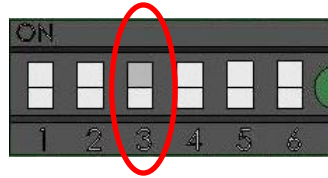

1	2	3
Switch Switch n ° 3 to ON then OFF	You have 2 minutes to close the table.	Follow the setup steps.

CONTRAST CONFIGURATION

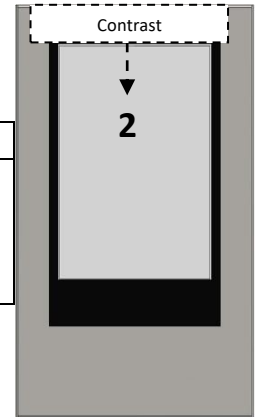
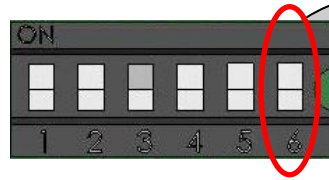

1	2	3	4
Set Switch N°6 on position ON	On the screen, the displayed number gives the level of contrast between 1 and 4.	When the level is good, switch the Switch No. 6 to OFF.	The table automatically saves the setting.

RESETTING THE PANEL

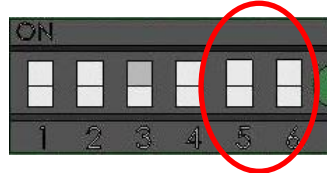

1	2	3	4	5
Toggle Switch 5 on position ON then Switch 6 on position ON	The board will display a message: ⇒ "Follow the directions"	Turn off and turn on the board.	Wait until the board lights up completely.	Set switches 5 and 6 to OFF.

HELP

<i>What is the failure ?</i>	<i>How to solve the problem!</i>
The panel does not turn on	<ul style="list-style-type: none"> - See Power recommendation (Must be 24VDC) - Check + / - wiring
Even after update, black screen with a white point.	<ul style="list-style-type: none"> - Check D+ / D- wiring
Incorrect calibration of the touch buttons or inability to calibrate.	Check the grounding of the power supply or the mechanics and re-calibrate.

Technical specifications :

Operating voltage	24Vdc max. (ES1) < 100W (PS2)	
Radio frequency characteristics	13.553 MHz - 13.567 MHz	< 60 dBµA/m @10m
Storage Temperatures range	-20 to +60°C	
Operating Temperatures range	-20 to +60°C	
Operating environment	IP52	



1 Go to the "notice boards" menu



2 Click "add a panel" and choose your residence



3 You can now add documents.
"General communication" to publish on all your display board.
"News" to publish on a particular display board.



4 Click update to send your document to the display board



Warranty operating guarantees:

The digital notice board FTA0014 is guaranteed within a temperature range of -20°C and +60°C and at a relative humidity level not exceeding 70%. IP 52.

It must be installed according to the Top/Bottom directions given in these instructions and on the device.

For optimal operation, it is recommended to ground the power supply or the mechanics.

The installation must be carried out by qualified personnel with the necessary knowledge for a safe assembly of the equipment.



End-of-life recycling of the product:

The digital notice board and its accessories must not be discarded with unsorted municipal waste, but must be disposed of via the WEEE (Waste Electrical and Electronic Equipment) collection and recycling system.

<https://fr.calameo.com/read/005135075b80fd84ae250>



Simplified declaration of conformity

The undersigned, COGELEC, declares that access control type radio equipment for collective housing is in compliance with Directive 2014/53 / EU (RED). The full text of the EU declaration of conformity is available at the following internet address: <http://certificates.intratone.com/>



STATUSBILDSCHIRM

Drücken Sie gleichzeitig die Tasten „<“ und „>“.

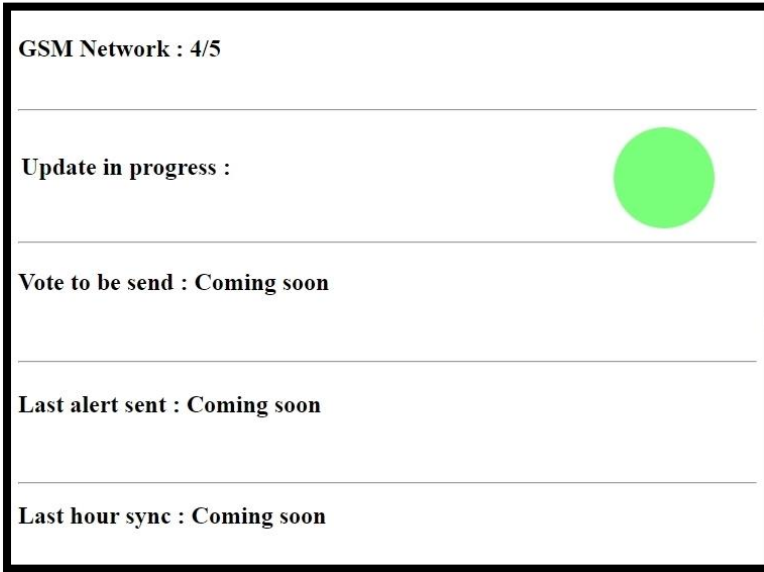

GSM-Netzwerk X / 5: Empfangsebene des 4G-Moduls.

Update läuft: Die Anzeige leuchtet grün, wenn ein Update durchgeführt wird.

Zu sendende Abstimmung: Die Ergebnisse der Abstimmung stehen noch aus.

Letzte gesendete Warnung: Letzter Alarmbericht.

Letzte Synchronisierung: Letzte Synchronisierung der Tabelle.

HAUPTFUNKTIONSTESTS

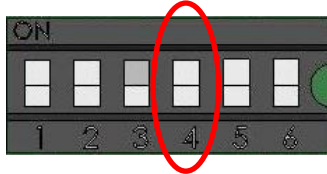



Stellen Sie den Schalter Nr. 4 auf „ON“ oder Drücken Sie die linke und rechte Taste 5 Sekunden lang.

TESTS

Die Testseite wird 2 Minuten lang angezeigt.

Buttons

Left  Reference : 2611 Threshold : 50 Level : 6680 Count : 2	Center  Reference : 2439 Threshold : 50 Level : 2439 Count : 0	Right  Reference : 2311 Threshold : 150 Level : 6689 Count : 3
---	---	---

Durch Drücken einer Taste sollte die entsprechende Anzeige aufleuchten.

Badge



Wenn Sie einen Transponder weitergeben, können Sie die Transpondererkennung lesen.

Test Pattern

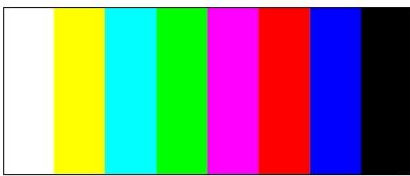

Farbtestmuster.

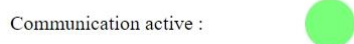

Die Kommunikation mit dem AUX-Port des 4G IP-Moduls ist gültig.

KALIBRIERUNG DER TOUCH-TASTEN

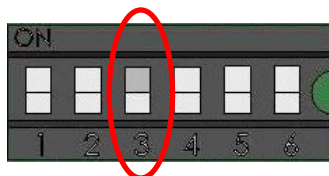

1	2	3
Stellen Sie den Schalter Nr. 3 auf „ON“ und anschließend wieder auf „OFF“. ODER halten Sie beim Start des Info-Displays einen Transponder für 5 Sekunden vor das Lesegerät.	Sie haben 2 Minuten Zeit, um das Display zu schließen.	Befolgen Sie die Installationschritte.

KONFIGURATION DES KONTRASTS

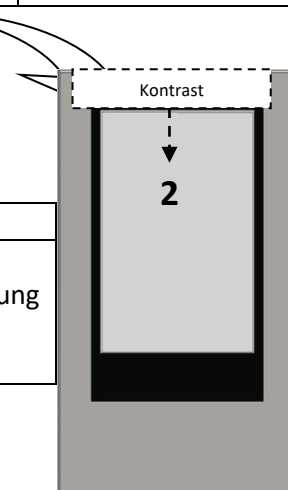
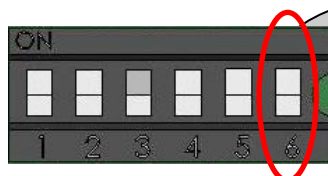

1	2	3	4
Schalter Nr. 6 auf „ON“ stellen.	Auf dem Bildschirm zeigt die angezeigte Zahl den Kontrast zwischen 1 und 4 an.	Wenn der Kontrast gut eingestellt ist, schalten Sie den Schalter Nr. 6 wieder auf „OFF“.	Das Info-Display speichert die Einstellung automatisch.

INITIALISIERUNG DES INFO-DISPLAYS

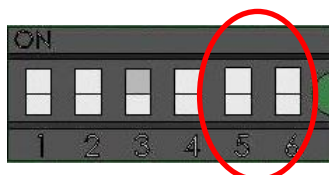

1	2	3	4	5
Schalter Nr. 5 auf „ON“ und dann Schalter Nr. 6 auf „ON“ stellen.	Das Info-Display zeigt eine Benachrichtigung an: ☑ "Folgen Sie den Anweisungen"	Schalten Sie das Info-Display aus und schalten Sie es wieder ein.	Warten Sie, bis das Info-Display vollständig aufleuchtet.	Schalten Sie die Schalter Nr. 5 und Nr. 6 wieder auf „OFF“.

Hilfe

DE : Problembeschreibung	Wie man das Problem löst!
Das Info-Display schaltet sich nicht ein.	<ul style="list-style-type: none"> - Stromversorgung überprüfen (Muss 24V DC sein) - Verkabelung + / - prüfen
Auch nach der Aktualisierung: "Keine Anzeige"	<ul style="list-style-type: none"> - Verkabelung D+ / D- prüfen
Falsche Kalibrierung der berührungsempfindlichen Tasten oder keine Möglichkeit, die Kalibrierung durchzuführen.	<ul style="list-style-type: none"> - Überprüfen Sie die Erdung der Stromversorgung oder der Mechanik und starten Sie erneut eine Kalibrierung.

Technische Spezifikationen :

Betriebsspannung	24Vdc max. (ES1) < 100W (PS2)	
Hochfrequenzeigenschaften	13.553 MHz - 13.567 MHz	< 60 dBµA/m @10m
Lagertemperaturbereich	-20 bis +60°C	
Betriebstemperaturbereich	-20 bis +60°C	
Betriebsumgebung	IP52	



1

Gehen Sie zum Menü "Anzeigetafeln"



2

Klicken Sie auf "eine Tabelle einfügen" und wählen Sie Ihre Wohnanlage

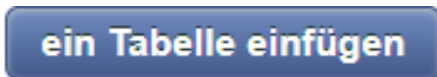

3

Sie können jetzt Dokumente hinzufügen.

"Allgemeine Kommunikation" zum Veröffentlichen auf all Ihren Info-Displays.

"Aktualitäten", die auf einem bestimmten Info-Display veröffentlicht werden sollen.

Allgemeine Kommunikation

Aktualitäten

Nachricht(en)

4

Klicken Sie auf "Aktualisieren", um Ihr Dokument an das Info-Display zu übertragen.

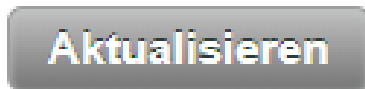

Funktionsgarantien:

Der Betrieb des digitalen Info-Displays FTA0014 ist für eine Temperaturspanne zwischen -20 °C und +60 °C und für eine relative Luftfeuchtigkeit von 70 % gewährleistet. IP52.

Das Info-Display muss, wie auf dem Gegensprechanlage angegeben, in der Richtung Oben/Unten eingebaut werden.

Für einen optimalen Betrieb wird empfohlen, das Netzteil oder die Mechanik zu erden.

Die Installation muss von qualifiziertem Personal mit den notwendigen Kenntnissen für eine sichere Montage der Ausrüstung durchgeführt werden.



Entsorgung des ausgedienten Geräts:

Das Digitale Info-Display und sein Zubehör dürfen nicht mit unsortiertem Hausmüll entsorgt werden, sondern müssen an Sammel- und Recyclestellen für Elektro- und Elektronikgeräte-Abfall abgegeben werden.

<https://fr.calameo.com/read/005135075b80fd84ae250>



Vereinfachte Konformitätserklärung

Der Unterzeichnende, COGELEC, erklärt, dass das funkgesteuerte Zugangskontrollgerät der Richtlinie 2014/53 / EU (RED) für den kollektiven Wohnungsbau entspricht. Der vollständige Text der EU-Konformitätserklärung ist unter folgender Internetadresse verfügbar: <http://certificates.intratone.com/>

STATUS SCHERM



Druk tegelijkertijd op de toetsen < en >.

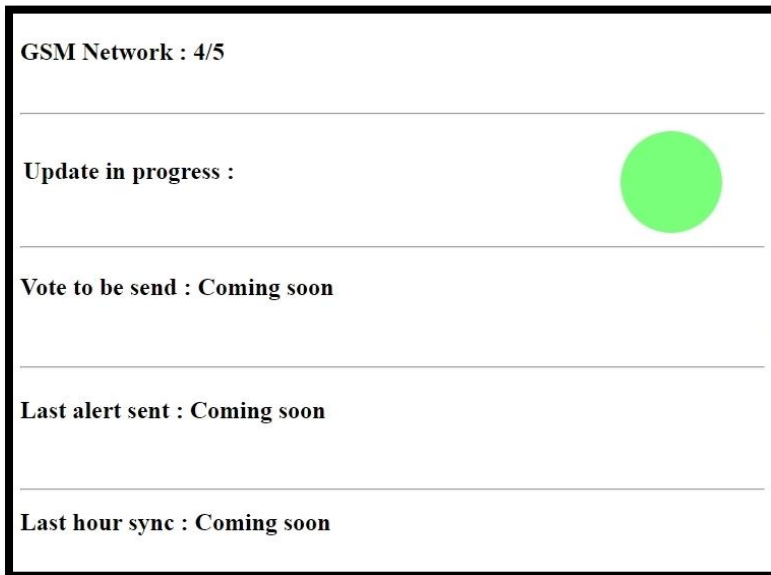

GSM-netwerk X / 5: ontvangstniveau van de 4G-module.

Update wordt uitgevoerd: de indicator is groen als er een update bezig is.

Stem om te verzenden: de resultaten van de stemming zijn in afwachting van download.

Laatste melding verzonden: Laatste melding.

Synchronisatie laatste uur: laatste synchronisatie van de tabel.

HOOFDFUNCTIETESTS





Dipswitch # 4 op AAN OF Druk 5 seconden op de linker en rechter touch-knop.

TESTS

De testpagina wordt gedurende 2 minuten weergegeven

Buttons

Left

Reference : 2611
Threshold : 50
Level : 6680
Count : 2

Center

Reference : 2439
Threshold : 50
Level : 2439
Count : 0

Right

Reference : 2311
Threshold : 150
Level : 6689
Count : 3

Wanneer een knop wordt ingedrukt, moet de bijbehorende indicator oplichten.

Badge



Last badge detected : 7480732

Als u een badge doorgeeft, kunt u het badgenummer aflezen

Test Pattern

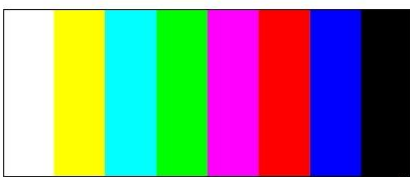

Kleurentestpatroon

Communication active :



Communicatie met de AUX-poort van de 4G IP-module is geldig..



KALIBRATIE VAN AANRAAKTOETSEN

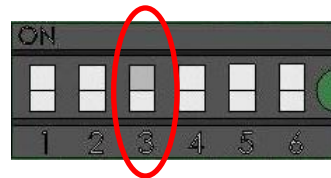

1	2	3
Zet schakelaar nr. 3 op AAN en vervolgens op UIT	Je hebt 2 minuten om de tafel te sluiten.	Volg de installatiestappen.

CONFIGURATIE VAN HET CONTRAST

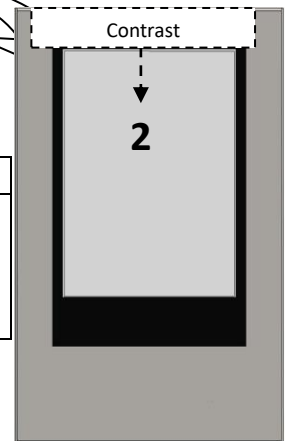
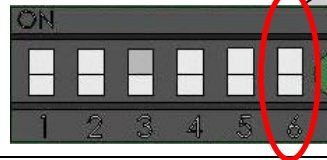

1	2	3	4
Zet schakelaar nr. 6 op ON.	Op het scherm geeft het weergegeven getal het contrastniveau weer tussen 1 en 4.	Wanneer het niveau goed is, zet schakelaar nr. 6 op UIT.	De tabel slaat de instelling automatisch op.

HERINITIALISATIE VAN HET BORD

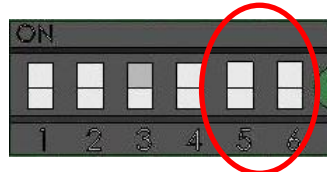

1	2	3	4	5
Zet schakelaar 5 op ON en schakelaar 6 op ON	Het bord geeft een bericht weer: ⇒ "Volg de aanwijzingen"	Schakel uit en schakel het bord in.	Wacht tot het bord helemaal oplicht.	Zet schakelaars 5 en 6 op UIT.

Helpen

<i>Wat is de melding?</i>	<i>Hoe het probleem op te lossen!</i>
Het bord licht niet op	- Zie aanbeveling voeding. (Moet 24 VDC zijn) - Controleer bekabeling + / -
Zelfs na updaten: 'Geen weergave'	- Controleer bekabeling D+ / D-
Onjuiste kalibratie van de aanraaktoetsen of onmogelijkheid om te kalibreren.	Controleer de aarding van de stroomtoevoer of het mechanisme en kalibreer opnieuw.

Technische specificaties :

Werkspanning	24Vdc max. (ES1) < 100W (PS2)	
Radiofrequentiekarakteristieken	13.553 MHz - 13.567 MHz	< 60 dBµA/m @10m
Opslagtemperatuurbereik	-20 to +60°C	
Bedrijfstemperatuurbereik	-20 to +60°C	
Operationele omgeving	IP52	



1

Ga naar het menu "borden"



2

Klik op "toevoegen" en kies uw woonplaats

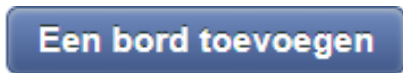

3

U kunt nu documenten toevoegen.
Algemene documentatie om te publiceren op al uw tabellen
Nieuws om te publiceren op een bepaalde tafel.



4

Klik op bijwerken om uw document naar het bord te sturen

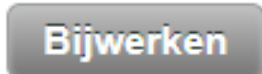

Werkingsgarantie:

Het Digitaal weergavebord voor binnen FTA0014 werkt bij temperaturen tussen -20°C et +60°C en bij een relatieve vochtigheid van ten hoogste 70%. IP52.

Moet gemonteerd worden met de juiste zijden naar boven en onder, zoals aangegeven op het intercom.

Voor een optimale werking is het raadzaam de voeding of het mechanisme te aarden.

De installatie moet worden uitgevoerd door gekwalificeerd personeel met de nodige kennis voor een veilige montage van de apparatuur.



Recycling aan het einde van de levensduur:

Het Digitaal weergavebord voor binnen en zijn toebehoren mogen niet als restafval worden afgevoerd, maar moeten ingeleverd worden bij inzamelpunten voor elektrische of elektronische apparatuur.

<https://fr.calameo.com/read/005135075b80fd84ae250>



Vereenvoudigde verklaring van overeenstemming

Ondergetekende, COGELEC, verklaart dat radioapparatuur voor toegangscontrole voor collectieve huisvesting voldoet aan Richtlijn 2014/53 / EU (RED). De volledige tekst van de EU-conformiteitsverklaring is beschikbaar op het volgende internetadres: <http://certificates.intratone.com/>



STATUSKÆRM

Tryk på knapperne <og> samtidigt.

GSM Network : 4/5

Update in progress : 

Vote to be send : Coming soon

Last alert sent : Coming soon

Last hour sync : Coming soon

GSM-netværk X / 5: Modtagelsesniveau for 4G-modulet.

Opdatering i gang: Indikatoren er grøn, hvis en opdatering pågår.

Afstem, der skal sendes: Resultaterne af afstemningen afventer download.

Sidste alarm sendt: Sidste alarmrapport.

Sidste timers synkronisering: Sidste gangssynkronisering af tabellen.

HOVEDFUNKTIONSTEST

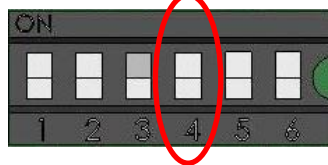



Drej switch 4 til ON OR Tryk på venstre og højre berøringsknapper i 5 sekunder.

TESTS

Testsiden vises i 2 minutter

Buttons

Left	Center	Right
		
Reference : 2611	Reference : 2439	Reference : 2311
Threshold : 50	Threshold : 50	Threshold : 150
Level : 6680	Level : 2439	Level : 6689
Count : 2	Count : 0	Count : 3

Ved at trykke på en tast lyser den tilsvarende indikator.

Badge



Last badge detected : 7480732

Ved at videregive en badge kan du læse badget-nummeret

Test Pattern

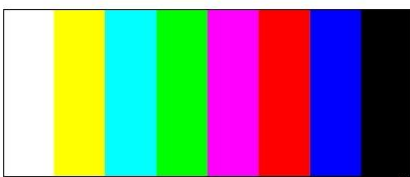

Farvekontrolmønster.

Communication active :



Kommunikation med AUX-porten i 4G IP-modulet er gyldig.

KALIBRERING AF BERØRINGSTASTER

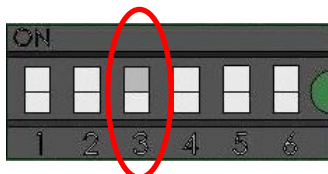

1	2	3
Sæt Skift n ° 3 til TIL og derefter FRA	Du har 2 minutter til at lukke tabellen.	Følg installationstrinnene.

CONFIGURACIÓN DEL CONTRASTE

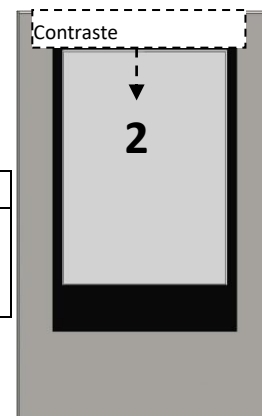
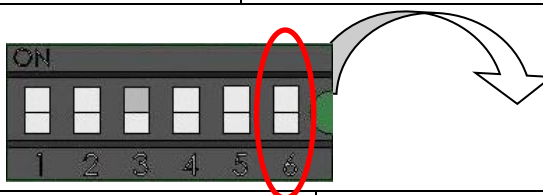

1	2	3	4
Cambie el interruptor No. 6 a ON.	En la pantalla, el número mostrado muestra el nivel de contraste entre 1 y 4.	Cuando el nivel es bueno, cambie el interruptor No. 6 a OFF.	La tabla guarda automáticamente la configuración.

REINICIO DEL PANEL

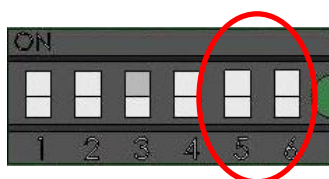

1	2	3	4	5
Conmutador 5 a ON y luego 6 a ON	La placa mostrará un mensaje: ⇒ "Seguir las instrucciones"	Apague y encienda el tablero.	Espere hasta que la placa se encienda por completo.	Cambie los interruptores 5 y 6 a OFF.

Ayudar

Hvad er fordelingen?	Sådan løses fejlen!
Panelet tændes ikke	<ul style="list-style-type: none"> - - Kontroller ledningerne mellem blokken og tavlen: +/- (Skal være 24VDC) - - Kontroller, at strømforsyningen skal være 24V.
Selv efter opdatering fra www.intratone.info viser skærmen kun en hvid prik.	<ul style="list-style-type: none"> - - Dårlige ledninger på terminalblokke D + og eller D-
Forkert kalibrering af berøringsknapperne eller manglende mulighed for at kalibrere.	<ul style="list-style-type: none"> - Kontroller strømforsyningens eller mekanikkens jordforbindelse, og kalibrer igen.

Tekniske specifikationer :

Driftsspænding	24Vdc max. (ES1) < 100W (PS2)	
Radiofrekvenssegenskaber	13.553 MHz - 13.567 MHz	< 60 dBµA/m @10m
Opbevaringstemperaturer spænder	-20 to +60°C	
Driftstemperaturer varierer	-20 to +60°C	
Driftsmiljø	IP52	



1 Gå til menuen "Tabel"



2 Klik på "tilføj en tabel" og vælg din bolig



3 Du kan nu tilføje dokumenter.
"Generel kommunikation" til at offentliggøre på alle dine borde.
"Nyheder" til at offentliggøre på et bestemt bord.



4 Klik på opdatering for at sende dit dokument til tavlen



Driftsgarantier:

FTA0014 displaypanelet er garanteret i et temperaturområde mellem -20°C og + 60°C og for en maksimal relativ fugtighed på 70%. Dets IP-indeks er 52.

Skal installeres i den retning op / ned, der anbefales på enheden.

For optimal drift anbefales det at jordforbinde strømforsyningen eller mekanikken.

Installationen skal udføres af kvalificeret personale med den nødvendige viden til sikker installation af udstyret.



Genbrug af produkter ved udgangen af livet:

Opslagstavlen og dets tilbehør må ikke kasseres med usorteret kommunalt affald, men skal følge indsamlings- og genvindingsprocessen for WEEE-produkter (affald af elektrisk og elektronisk udstyr).

<https://fr.calameo.com/read/005135075b80fd84ae250>



Forenklet overensstemmelseserklæring

Undertegnede, COGELEC, erklærer, at radioudstyr af adgangskontroltypen til kollektive boliger er i overensstemmelse med direktiv 2014/53 / EU (RED). Den fulde tekst til EU-overensstemmelseserklæringen er tilgængelig på følgende internetadresse: <http://certificates.intratone.com/>