

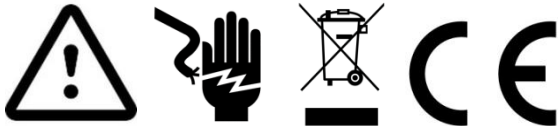

CARTE EXTENSION 2 PORTES EXTENTION BOARD AND 2 DOORS

Ref : 12-0109

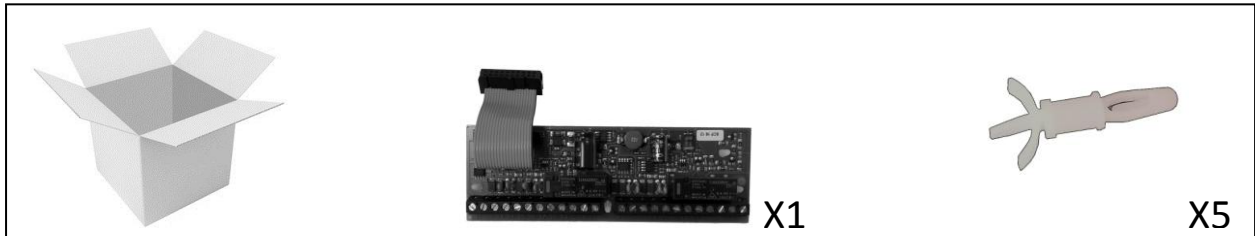
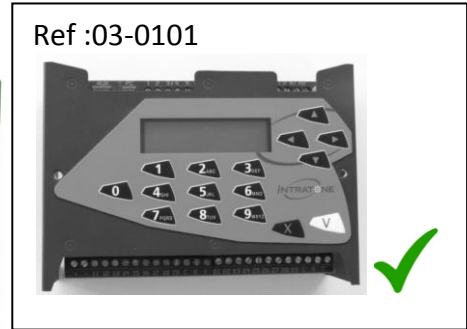
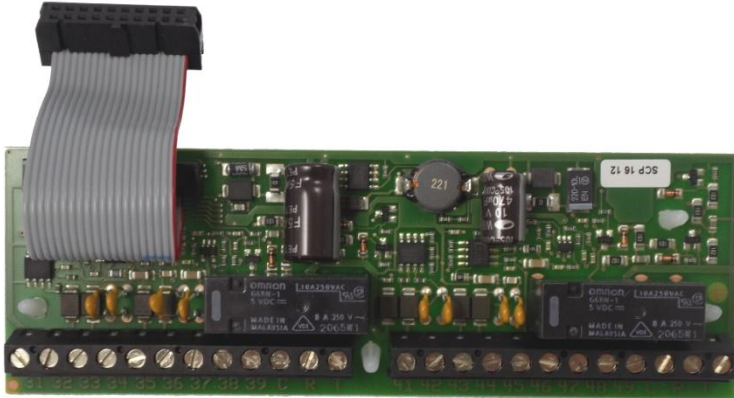

CE 
R&TTE 1999/5/CE
EN 301 489-3 (2002)
EN 300 220-3 (2001)

FRANÇAIS ATTENTION! Toujours couper l'alimentation au panneau principal avant de procéder à l'installation.

ENGLISH Warning! Shut the power supply off before the installation.

SUOMI TÄRKEÄÄ! Katkaise aina virta pääkatkaisimesta ennen asennuksen aloittamista.

ESPAÑOL ¡IMPORTANTE! Desconecta siempre el interruptor general de electricidad antes de empezar la instalación.

NEDERLANDS BELANGRIJK! Schakel de stroom altijd uit voordat met de installatie wordt begonnen.

DEUTSCH WICHTIG! Vor der Installation den Strom abschalten.

DANSK VIGTIGT! Sluk altid for strømmen, før installationen påbegyndes.





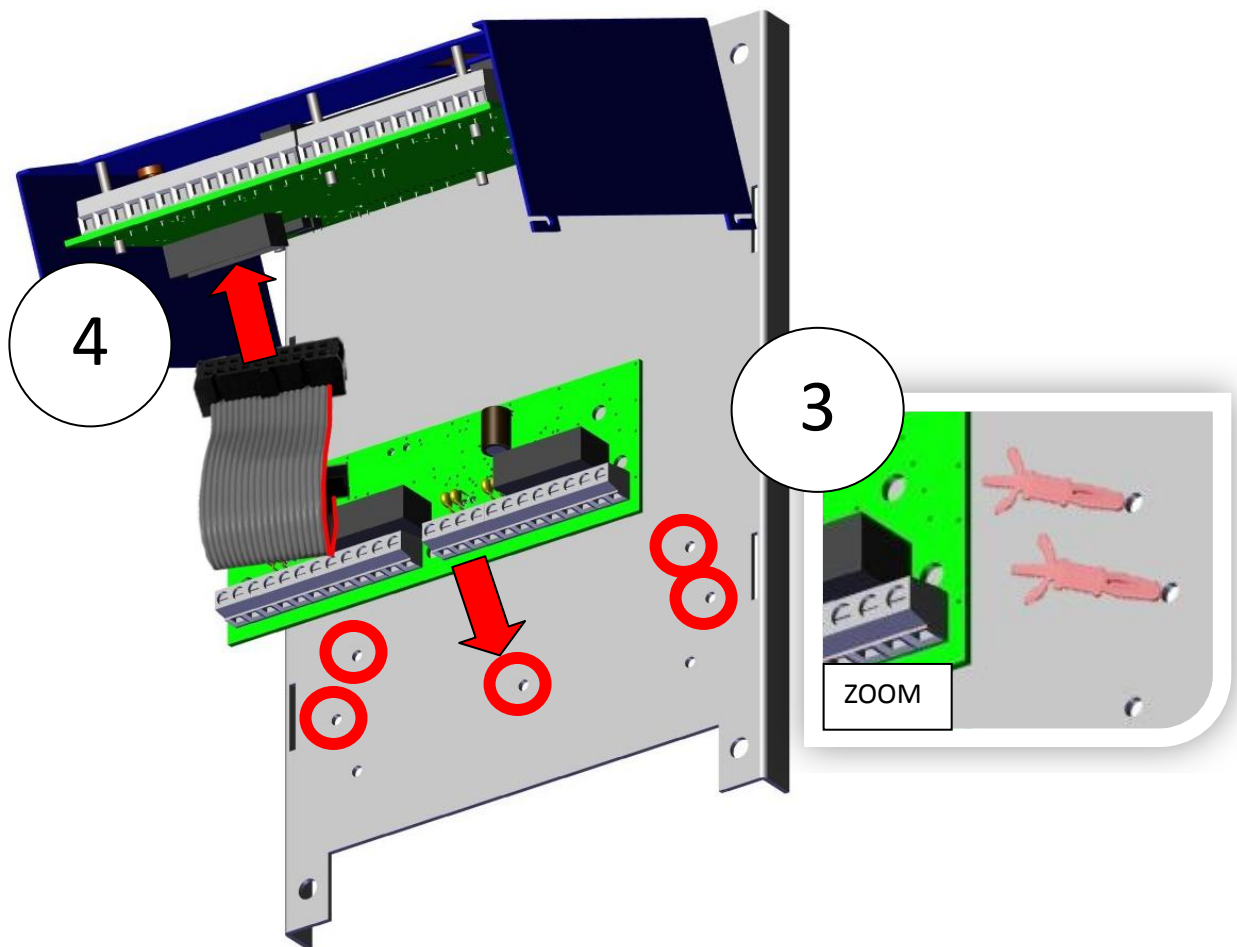
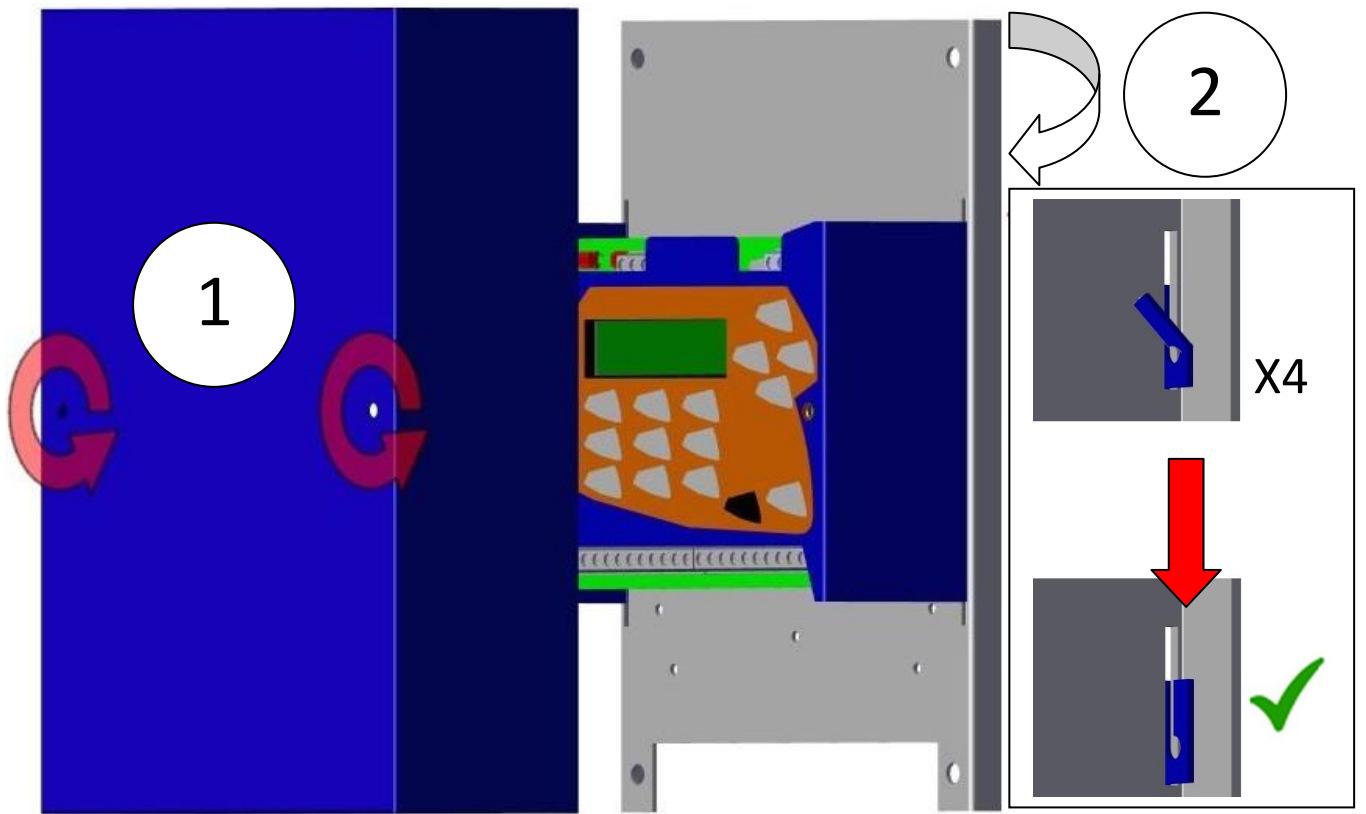

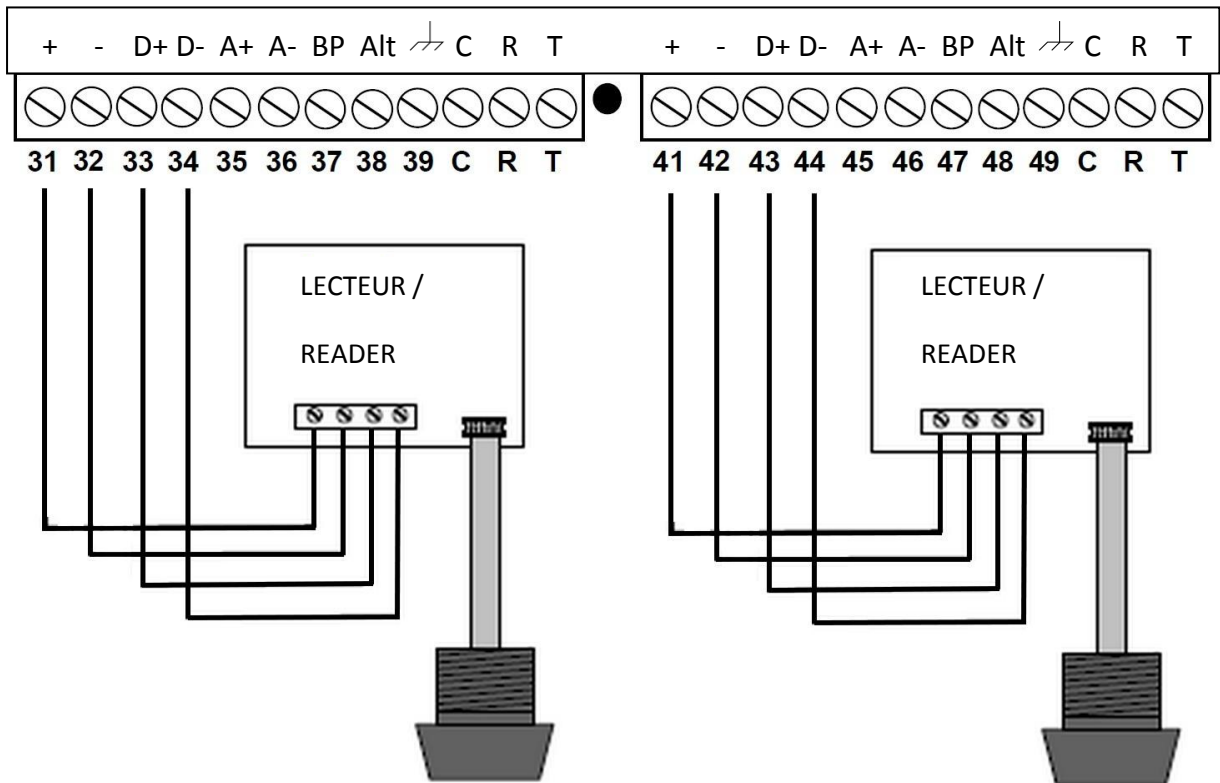
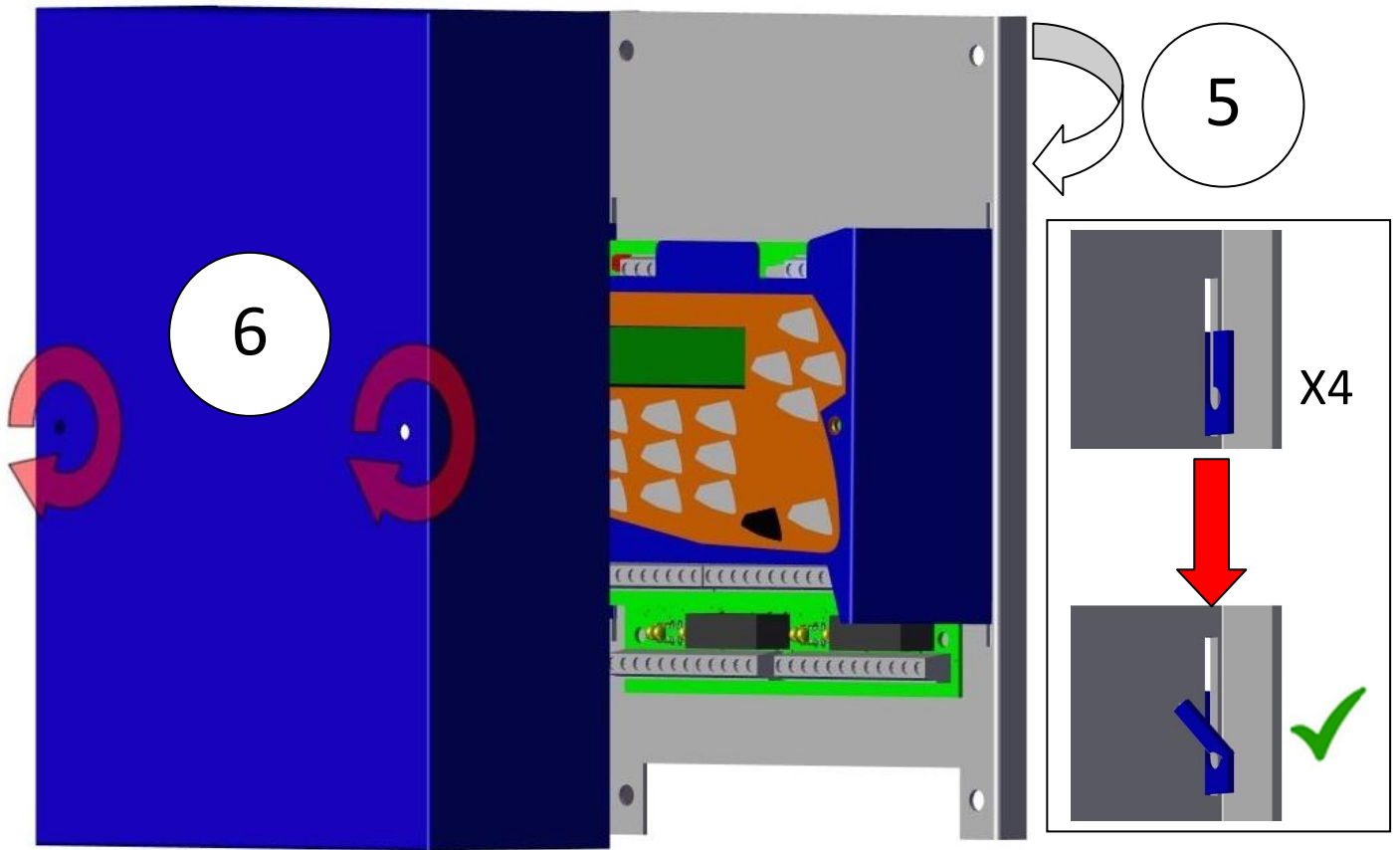



























NORSK VIKTIG! Elektriske installasjoner skal utføres av elektriker.

SVENSKA VIKTIGT! Stäng alltid av strømmen innan installation påbörjas.





http://www.intratone.info

 Programmation Centrales	<table border="1"><thead><tr><th>Nom</th><th>Série</th><th>Téléphone</th><th>Type</th></tr></thead><tbody><tr><td>Test</td><td>00020001</td><td></td><td></td></tr></tbody></table>	Nom	Série	Téléphone	Type	Test	00020001			⇒	Carte Extension (HCEXG)	Oui <input checked="" type="radio"/> Non <input type="radio"/>
Nom	Série	Téléphone	Type									
Test	00020001											
 Communication / Central units	<table border="1"><thead><tr><th>Name</th><th>Serial</th><th>Phone</th><th>type</th></tr></thead><tbody><tr><td>Test</td><td>00020001</td><td></td><td></td></tr></tbody></table>	Name	Serial	Phone	type	Test	00020001			⇒	Extension card (HCEXG)	Yes <input type="radio"/> No <input type="radio"/>
Name	Serial	Phone	type									
Test	00020001											
 Kommunikation / Zentralen	<table border="1"><thead><tr><th>Name</th><th>Serie</th><th>Telefon</th><th>Typ</th></tr></thead><tbody><tr><td>Test</td><td>00020001</td><td></td><td></td></tr></tbody></table>	Name	Serie	Telefon	Typ	Test	00020001			⇒	Steckkarte (HCEXG)	Ja <input type="radio"/> Nein <input type="radio"/>
Name	Serie	Telefon	Typ									
Test	00020001											
 Kommunikation / Centrales	<table border="1"><thead><tr><th>Naam</th><th>Serie</th><th>Telefoonnummer</th><th>type</th></tr></thead><tbody><tr><td>Test</td><td>00020001</td><td></td><td></td></tr></tbody></table>	Naam	Serie	Telefoonnummer	type	Test	00020001			⇒	Uitbreidingskaart (HCEXG)	Ja <input checked="" type="radio"/> Nee <input type="radio"/>
Naam	Serie	Telefoonnummer	type									
Test	00020001											
 Keskuksset	<table border="1"><thead><tr><th>Huoneistotunnus</th><th>Sarja</th><th>Puhelin</th><th>tyyppi</th></tr></thead><tbody><tr><td>Test</td><td>00020001</td><td></td><td></td></tr></tbody></table>	Huoneistotunnus	Sarja	Puhelin	tyyppi	Test	00020001			⇒	Laajennuskortti (HCEXG)	Kyllä <input type="radio"/> Ei <input type="radio"/>
Huoneistotunnus	Sarja	Puhelin	tyyppi									
Test	00020001											
 Kommunikasjon / Sentralenheter	<table border="1"><thead><tr><th>Etternavn</th><th>Serie</th><th>Telefon</th><th>Type</th></tr></thead><tbody><tr><td>Test</td><td>00020001</td><td></td><td></td></tr></tbody></table>	Etternavn	Serie	Telefon	Type	Test	00020001			⇒	Utvidelseskort (HCEXG)	Ja <input type="radio"/> Nei <input type="radio"/>
Etternavn	Serie	Telefon	Type									
Test	00020001											
 Kommunikation / Centralenheter	<table border="1"><thead><tr><th>Efternamn</th><th>Serie</th><th>Telefon</th><th>typ</th></tr></thead><tbody><tr><td>Test</td><td>00020001</td><td></td><td></td></tr></tbody></table>	Efternamn	Serie	Telefon	typ	Test	00020001			⇒	Expansionskort (HCEXG)	Ja <input type="radio"/> Nej <input type="radio"/>
Efternamn	Serie	Telefon	typ									
Test	00020001											
 Kommunikation / Centralenheder	<table border="1"><thead><tr><th>Efternavn</th><th>Serie</th><th>Telefon</th><th>Type</th></tr></thead><tbody><tr><td>Test</td><td>00020001</td><td></td><td></td></tr></tbody></table>	Efternavn	Serie	Telefon	Type	Test	00020001			⇒	Udvidelseskort (HCEXG)	Ja <input type="radio"/> Nej <input type="radio"/>
Efternavn	Serie	Telefon	Type									
Test	00020001											
 Comunicación / Centrales	<table border="1"><thead><tr><th>Apellido</th><th>Serie</th><th>Teléfono</th><th>tipo</th></tr></thead><tbody><tr><td>Test</td><td>00020001</td><td></td><td></td></tr></tbody></table>	Apellido	Serie	Teléfono	tipo	Test	00020001			⇒	Tarjeta Extensión (HCEXG)	Si <input type="radio"/> No <input type="radio"/>
Apellido	Serie	Teléfono	tipo									
Test	00020001		